

# FURIOUS 320 CL

QUICK START GUIDE **V1.0**

9th-DEC-2015

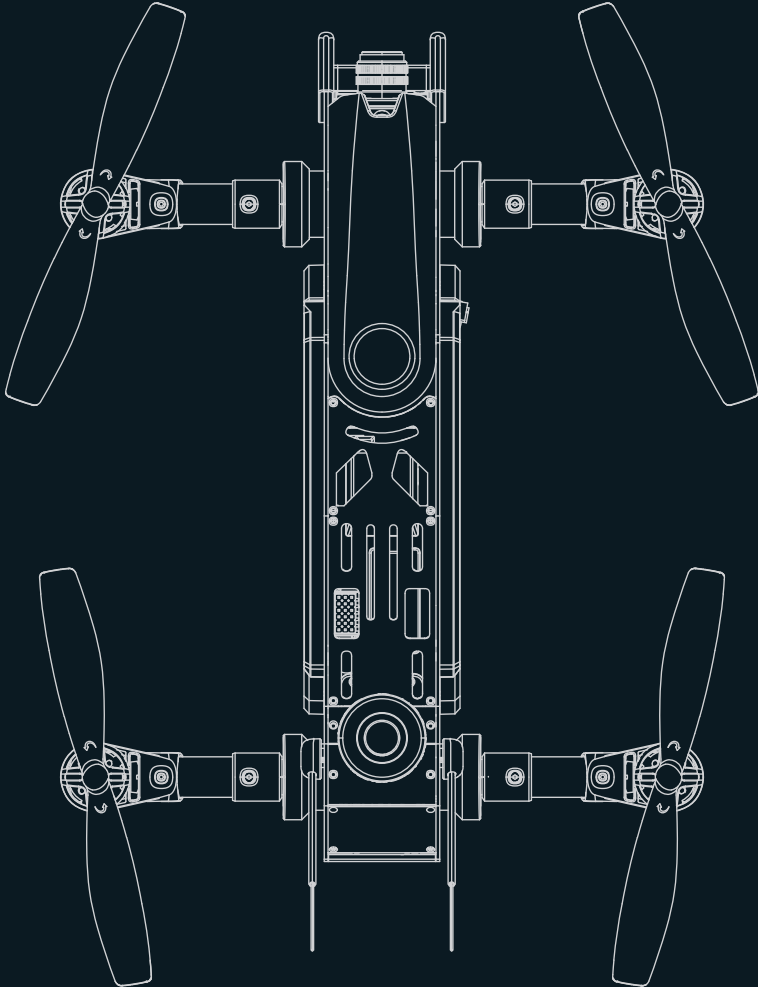

# Contents

1.0 Get to know your aircraft .....	2
2.0 Get to know your Remote Controller .....	3
3.0 Specifications .....	4
4.0 Attention before flight .....	5
5.0 Charge the Battery .....	5
6.0 Assemble .....	5-6
7.0 Ready for flight .....	7
7.1 Binding of the FURIOUS 320 .....	7
7.2 Motor Unlock / Lock .....	7-8
7.3 Motor Idle Speed System .....	8
7.4 Flight mode indicator light instruction .....	8
8.0 Operation Instruction .....	9-11
9.0 End flight .....	11
10.0 Additional remark .....	12
10.1 DEVO-10 Remote Controller Setting .....	12-14
10.2 OSD(C) information .....	14
10.3 TX5821(FCC)/TX5820(CE) emitter transmitting channel selection .....	14
10.4 Introduction for power plate .....	15
10.5 Introduction for FURIOUS 320 OSD(C) .....	16
10.6 Introduction for DEVO-RX712 receiver .....	16
10.7 Introduction for FCS-FURIOUS 320(C) Main Controller .....	17
10.8 Blushless ESC and Blushless Motor connection diagram .....	17
11.0 Camera(1920x1080P) Instructions .....	18-19
12.0 Instructions for GA009 balance charger .....	20

## 1.0 Get to know your aircraft

- Adopting the CFP material for the main body, the racer possesses superior toughness and strong anti-impact ability.
- The brand new industrial and modular design, greatly improve the product extension, which enable it much easier to maintain and upgrade.
- The 5.8G real-time image transmission system and OSD system, can bring you the unforgettable visual enjoyment.
- The racer can do acrobatic flights such as roll up-to-down, left-to-right, dream baron. Which gives the user unparalleled flight enjoyment.

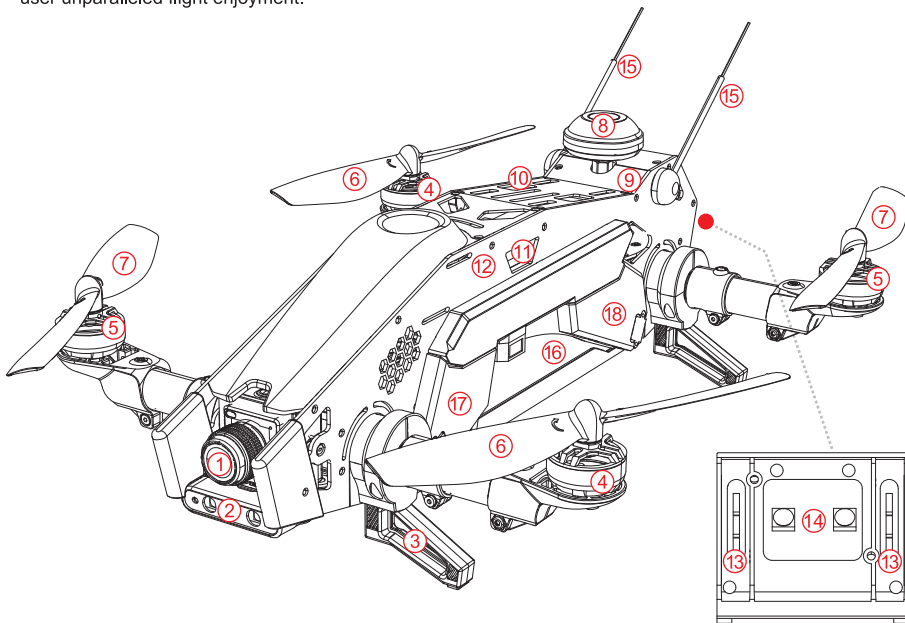



- |  |   |
|--|---|
| 1. Camera  | 9. TX5821(FCC)/TX5820(CE) emitter       |
| 2. Front LED light   | 10. DEVO-RX712 Receiver                 |
| 3. Landing gear  | 11. FCS-FURIOUS 320(C) Main Controller  |
| 4. Clockwise motor (levogyrate thread is counterclockwise)   | 12. FURIOUS 320 OSD(C)                  |
| 5. Counterclockwise motor (dextrogyrate thread is clockwise) | 13. Direction indicator light           |
| 6. Clockwise propeller                                       | 14. Rear LED light                      |
| 7. Counterclockwise propeller                                | 15. Receiver antenna                    |
| 8. Mushroom antenna  | 16. Battery: 14.8V 2600mAh 25C 4S Li-Po |
|  | 17. Brushless ESC(CW)                   |
|  | 18. Brushless ESC(CCW)                  |

## 2.0 Get to know your Remote Controller

Equipped with function switches included the primary/intermediate/advanced flight mode swithes, and camera control switch etc, which makes the DEVO-10 easier to operate.

**(You can select suitable flight mode according to your flying skill.)**

<b>MODE 2</b> (Throttle stick on the left)	Left stick	THRO/RUDD stick
	Right stick	ELEV/AILE stick
	Left trim	THRO trim
	Right trim	ELEV trim
<b>MODE 1</b> (Throttle stick on the right)	Left stick	ELEV/RUDD stick
	Right stick	THRO/AILE stick
	Left trim	ELEV trim
	Right trim	THRO trim

Primary Flight Mode	Intermediate Flight Mode	Advanced Flight Mode
		
MIX Switch to "0"	MIX Switch to "1"	MIX Switch to "2"

1. RUDD D/R switch
2. ELEV D/R Switch
3. AUX4 Knob-  
adjust the angle of aircraft arm
4. GEAR switch - Camera start/Stop
5. Left stick
6. Left trim
7. RUDD trim
8. UP key
9. DN key
10. EXT key
11. AUX5 Knob
12. MIX - Flight Mode Switch
13. AILE D/R Switch
14. FMOD Switch-  
Motor Idle Speed System
15. Right stick
16. Right trim
17. AILE trim
18. Power switch
19. R key
20. L key
21. ENT key

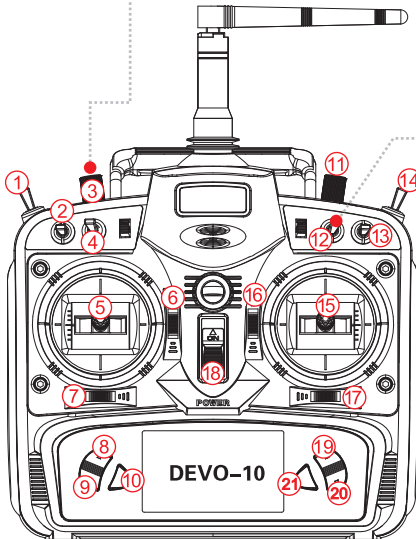
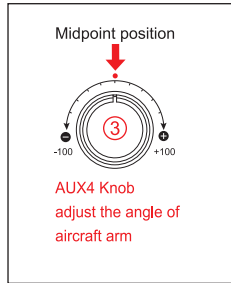

## 3.0 Specifications

### Aircraft

Main Rotor Dia.:	167mm
Overall (L x W x H):	328 x 254 x 118mm
Weight:	810g (Battery excluded)
Remote Controller:	DEVO 10
Receiver:	DEVO-RX712
Main Controller:	FCS-FURIOUS 320(C)
Emitter:	TX5821(FCC)/TX5820(CE)
OSD:	FURIOUS 320 OSD(C)
Brushless Motor:	WK-WS-28-015(CW/CCW)
Brushless ESC:	FURIOUS 320(CW/CCW)
Battery:	14.8V 2600mAh 25C 4S LiPo
Flight Time:	9~10mins
Working Temperature:	-10 C ~ +40 C

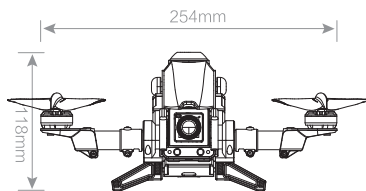
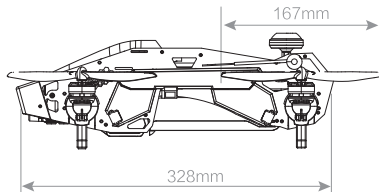

---

### Camera(1920x1080P)

Video Resolution:	1920x1080P 60FPS
Micro SD card:	Max 32G
Video Format:	MOV
Photo:	4000x3000 Pixels
Photo Format:	JPG
Power Input:	DC 5V

### Camera(800TVL)

Horizontal Resolution:	800TVL
System Committee:	PAL/NTSC
Video Out:	1.0Vp-p/75Ω
Power Input:	DC 12V

---

### TX5821(FCC) / TX5820(CE) Emitter

5.8G wireless image transmission

TX5821(FCC) Bind B section: 4 channels

TX5820(CE) B section: 8 channels

TX5821(FCC) output power ≤200mW

TX5820(CE) output power ≤25mW

## 4.0 Attention before flight

- This product is suitable for people who has flight experience of hobby model and ages 14+.
- Please do not fly the FURIOUS 320 advance in the situation that the windpower is more than level 3, either in rainy, sowny or foggy etc bad weather.
- Please choose the open, legal field to fly, and consider your flight skills and mental status.
- Please keep a certain distance with aircraft and away from the highspeed rotating parts (such as propellers, brushless motor) during flying.
- Do not fly it in where there is high-voltage lines, communication base stations or radio towers, in order to avoid signal interference.
- Don't fly in no-fly zone according to the local laws and regulations.

## 5.0 Charge the Battery

- ① Insert the power adapter(100~240V 50/60HZ), connect the output end to the GA009 balance charger, the balance charger is green LED light flashing.
- ② Insert the balanced pin of LiPo battery into GA009.
- ③ During charging, the red LED light is solid. When the charger will be completed, the red and green LED lights flash alternately. The charging is completed, the green LED light is solid.



### Attention:

- (1) When the yellow LED light flashes, there may be something wrong with charger or battery, so please stop charging
- (2) Please refer to Page 20 for details of GA009 balance charger.

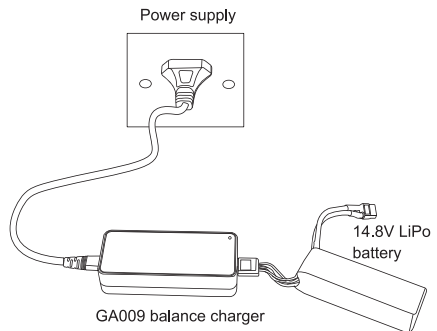

## 6.0 Assemble

### Install mushroom antenna

Firstly install mushrooms antenna onto the emitter, and tighten with open-end wrench.

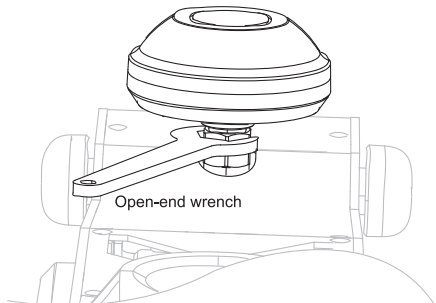

## Install propellers

Fix the clockwise propeller onto the clockwise motor according to the direction of blue arrow, and fix the counterclockwise propeller onto the counterclockwise motor according to the direction of orange arrow. Tighten the propellers manually and make sure the propeller is installed in proper way and fastened.



### Attention:

To convenient install or take off the propellers, please use the open-end wrench to hold the motor side hood (shown at right).

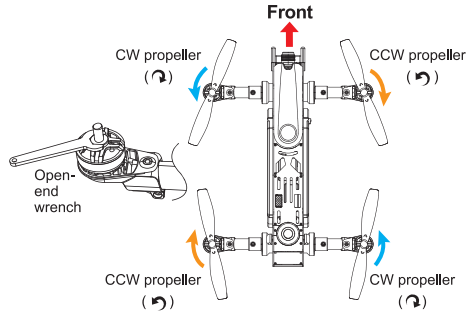

## Battery installation

Move battery cover button, open the battery cover, put the battery into the drone, adjust the drone's center of gravity, so th head and tail are in the same horizontal line, after adjusted, fix the battery with belt and close the battery cover.

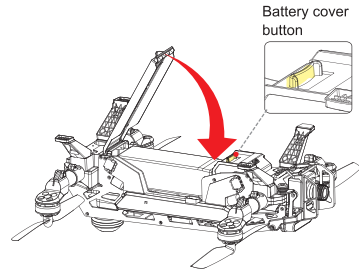

## Gravity center adjustment:

Hold the gravity center line for the fulcrum to balance it. If the head inclines to drop, indicates the gravity center in the head part, require to move the battery backward;

On the contrary, If the tail inclines to drop, indicates the gravity center in the tail part, require to move the battery forward.

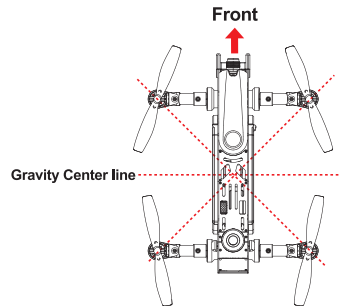

### Attention:

The receiver antenna has to be straightened before the flight, to lengthen the communication distance.

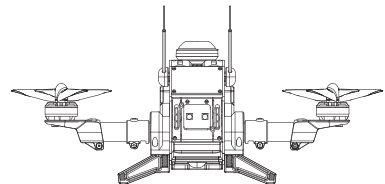

## 7.0 Ready for flight

### ⚠ Attention:

- (1) Place the aircraft on a flat surface, in an open space, with the back facing you.
- (2) Put all the function switches to the 0 position, put all trims/knobs to the Middle position, move the throttle to the lowest position, then turn on the Remote Controller.
- (3) FURIOUS 320 has low voltage warning, no low voltage protection:  
When the voltage below 14.2V, Left and right direction lights will flash slowly and the buzzer will alarm, please land ASAP, to avoid crash.

## 7.1 Binding of the FURIOUS 320

- ① Turn on the Remote Controller. (Make sure all the function switches, all trims/knobs and throttle stick at the correct position)
- ② Put the aircraft to the horizontal place and connect the aircraft power. (make sure the positive and negative connected correctly )
- ③ The rear red LED flashes from fast to slow indicating that the code binding has finished.  
(Note: When binding, do not move the FURIOUS 320.)

After bind successfully, please keep the aircraft arms level. The checking methods are as follow:  
Adjust the AUX4 knob of the controller slowly to the best position where the user toggle the MIX swith, the aircraft arms do not move.

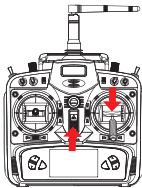

①

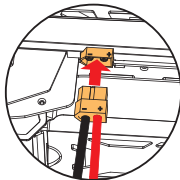

②

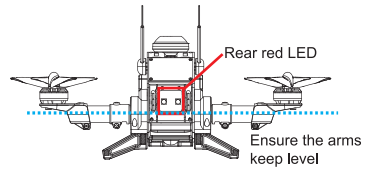

③

## 7.2 Motor Unlock / Lock

### ● Motor Unlock

After binding the DEVO-10 to the FURIOUS 320, Check that all trims are neutral, the throttle stick is ALL the way Down with the display indicating 0% throttle. Check that ALL switches are in the UP position. Gently push the throttle stick down and move the rudder (YAW) stick to the left side and **hold for more than 2 seconds**. (on mode 2 radios throttle and rudder is the same stick). You will see the rear red LED light flash fast, indicating that motors are unlocked. Be very careful at this point, as pushing the thottle up will start the motors. You can test by pushing the stick up a little, the motors should start.

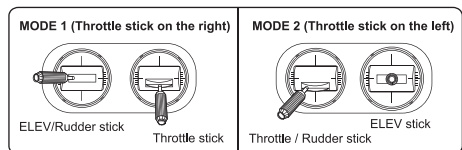



## ● Motor Lock

Lock the motors by moving the throttle stick all the way down and the rudder (YAW) stick all the way to the right. The rear red LED light flashes slowly when the motors are disarmed.

**TEST:** Push the throttle stick up a little, the motors will not start when locked.

**NOTICE:** The motors are LOCKED by default after successful binding.

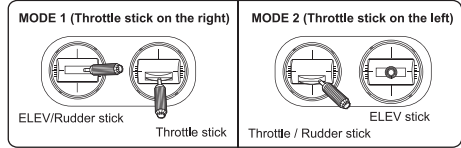



## 7.3 Motor Idle Speed System



**Attention:**

**After the motor unlocked, the motor idle speed system should be started;**



**After finished the flight, please inhibit the motor idle speed system. as below:**

On/Off	Remote Controller Switch	Instruction
Activate the motor idle speed system	 <p>FMOD switch to "2" position</p>	When the throttle at the lowest position, the motor will spin.
Inhibit the motor idle speed system	 <p>FMOD switch to "0" position</p>	When the throttle at the lowest position, the motor will stop spinning.

## 7.4 Flight mode indicator light instruction

Mode	Remote Controller Switch	The indicator status
Primary Flight Mode	 <p>MIX switch to "0" position</p>	The rear red LED of aircraft flashes once quickly
Intermediate Flight Mode	 <p>MIX switch to "1" position</p>	The rear red LED of aircraft flash twice quickly
Advanced Flight Mode	 <p>MIX switch to "2" position</p>	The rear red LED of aircraft flash 3 times quickly

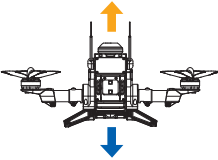
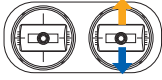
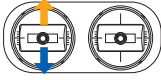
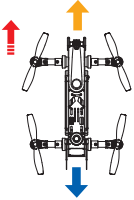
## 8.0 Operation Instruction

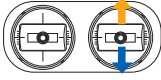
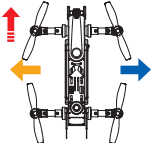
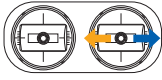
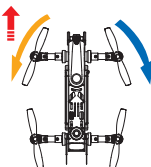
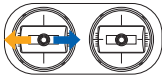
Aircraft posture( ← the direction of head)	Remote Controller control instruction	
<p><b>THROTTLE</b> Up/down The tail toward operator</p> 	 <p>MODE 1 (Throttle stick on the right)</p>	 <p>MODE 2 (Throttle stick on the left)</p>
<p><b>PITCH</b> Forward/backward When backward, the left/ right direction indicator lights will be solid.</p> 	 <p>MODE 1 (Throttle stick on the right)</p>	 <p>MODE 2 (Throttle stick on the left)</p>
<p><b>ROLL (lean)</b> Left / right When lean left, the left direction indicator light will be solid. When lean right, the right direction indicator light will be solid.</p> 	 <p>MODE 1 / MODE 2</p>	
<p><b>YAW (turn)</b> Left / right When turn left, the left direction indicator light will flash. When turn right, the right direction indicator light will flash.</p> 	 <p>MODE 1 / MODE 2</p>	

## The aircraft roll forward

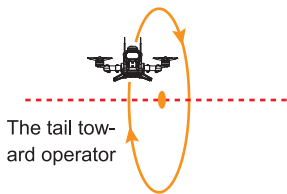

Ensure the MIX switch on "1" or "2" position, namely Intermediate Flight Mode or Advanced Flight Mode.

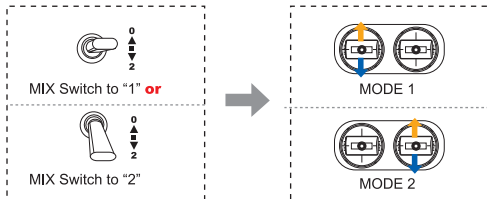

## The aircraft roll backward

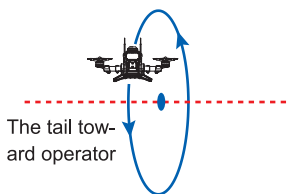

### Attention:

- (1) Please select a larger space, soft ground for flying.
- (2) The rolling mode is more suitable for experienced pilots.
- (3) Need match the throttle for practice during the rolling, when the aircraft drop please up throttle a bit, when the aircraft rise please down the throttle a little.

## The aircraft roll left

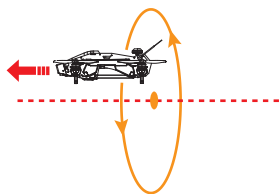

Ensure the MIX switch on "1" or "2" position, namely Intermediate Flight Mode or Advanced Flight Mode.

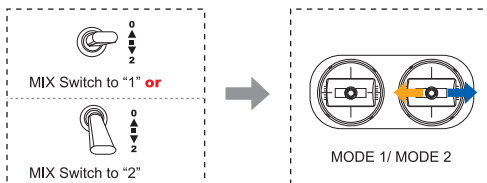

## The aircraft roll right

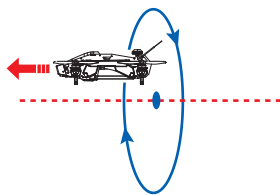

### Attention:

- (1) Please select a larger space, soft ground for flying.
- (2) The rolling mode is more suitable for experienced pilots.
- (3) Need match the throttle for practice during the rolling, when the aircraft drop please up throttle a bit, when the aircraft rise please down the throttle a little.

**Dream Baron**

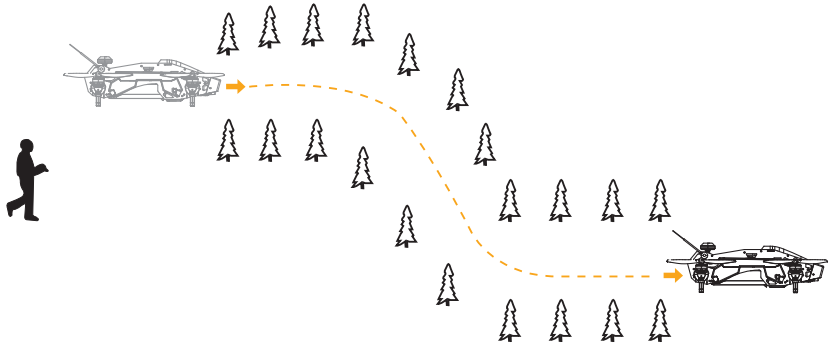

**Attention:**

- (1) Dream Baron is more suitable for experienced pilots.
  - (2) During the flying, please keep in sight of 50 meters or video control range within 300 meters to control the flight.(Actual range depending on the flight environment and weather conditions.)
  - (3) During the flying, please avoid obstacles such as people, animals and power lines.
- 

## 9.0 End flight

- ① Manual landing.
- ② First, power off aircraft battery, then power off Remote Controller battery.
- ③ Take the battery out of aircraft.

## 10.0 Additional remark

### 10.1 DEVO-10 Remote Controller Setting

- Boot Screen(Main interface)

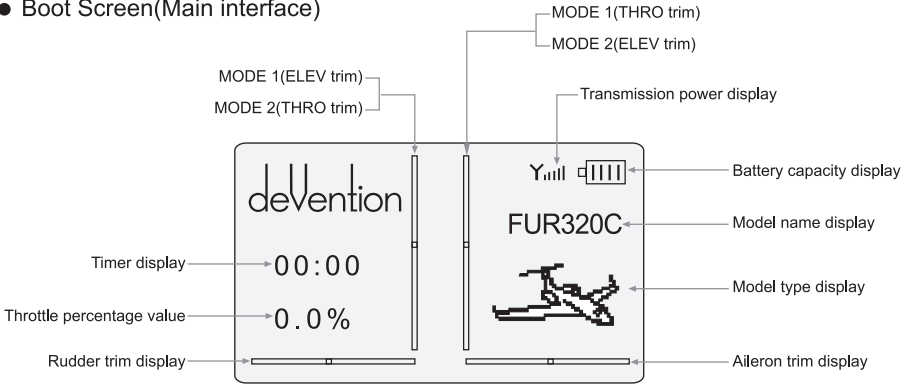

- Type Select

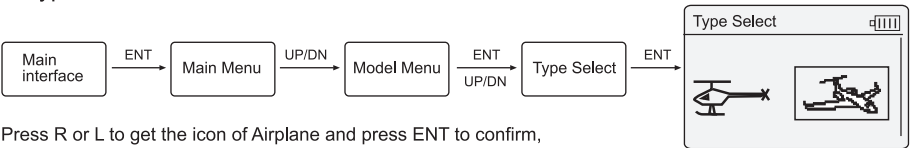

Press R or L to get the icon of Airplane and press ENT to confirm, then press EXT to return to Model Menu.

- Model Select

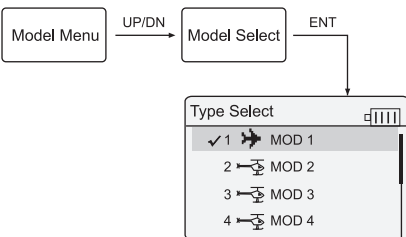

Press UP or DN to select MOD 1, press ENT to confirm and then press EXT to return to Model Menu.

- Model Name

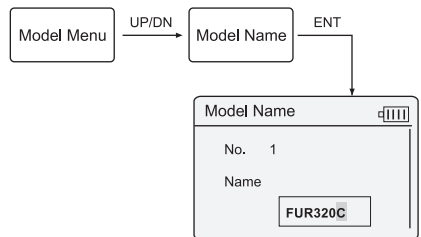

Press UP or DN to select the character and figure which need to be changed Press R or L to change the character and figure, named model as FUR320C. Press ENT to confirm and then press EXT to return to Model Menu.

● Wing Type

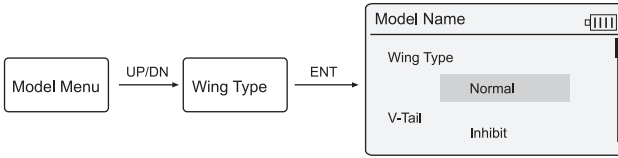

Press UP or DN to select Wing Type setting, press R or L to select Normal, then press ENT to confirm and then press EXT to return to Model Menu.

● Device Output

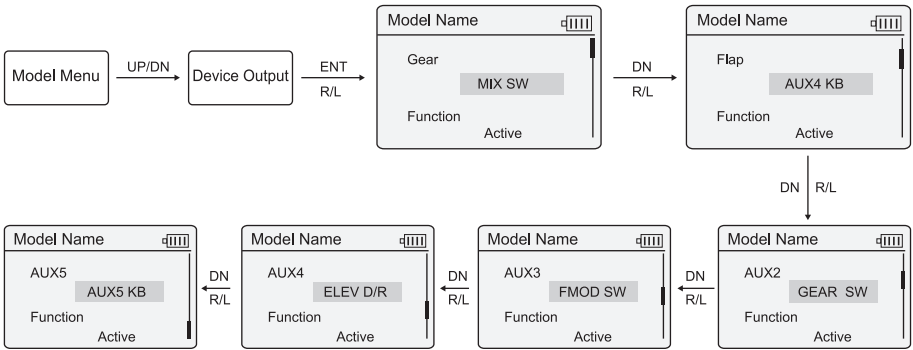

After finish settings, press ENT to confirm and then press EXT to return to Main Menu.

● Reverse Switch

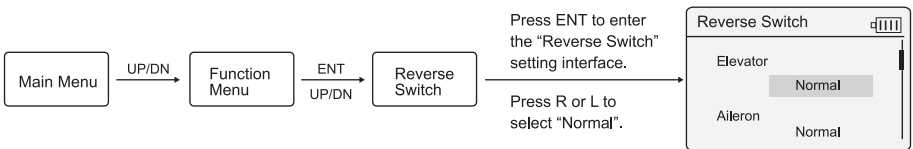

Press ENT to enter the "Reverse Switch" setting interface.  
Press R or L to select "Normal".

Elevator	Aileron	Throttle	Rudder	Gear	Flap	AUX2	AUX3	AUX4	AUX5
Normal	Normal	Normal	Normal	Normal	Normal	Normal	Normal	Normal	Normal

After finish settings, press ENT to confirm and then press EXT to return to Function Menu.

## • Program MIX

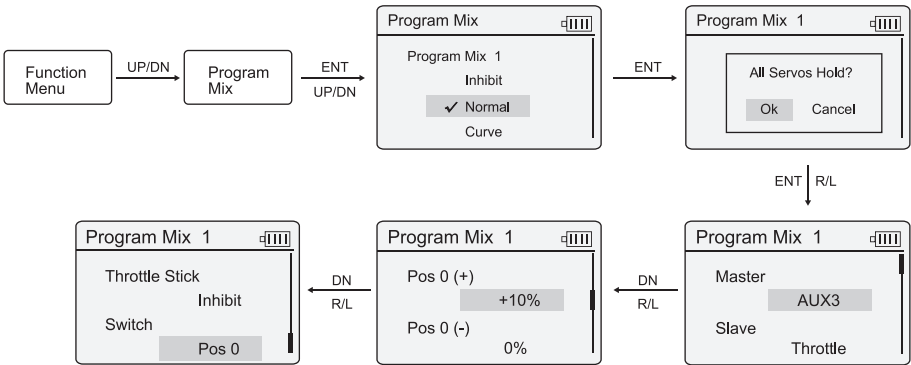

Keep the other options as default settings, no need to change them, please press ENT to confirm after settings finished and press EXT back to main interface.



**Attention: Other Program Mix should be inhibited.**

## 10.2 OSD(C) information

The OSD information will display only if there is video-receiving equipment.

Slide the video switch and OSD(C) module code switch "1" to "ON", please refer to page 15~16.

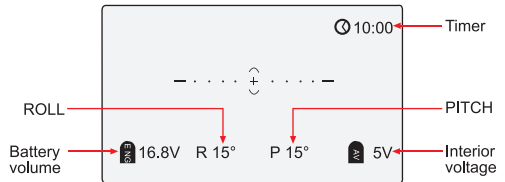

## 10.3 TX5821(FCC)/TX5820(CE) emitter transmitting channel selection

There are 8 different channels can be selected. You can choose the best channel according to the image quality as bellow:

Channel	1	2	3	4	5	6	7	8
Frequency	5866MHz	5847MHz	5828MHz	5809MHz	5790MHz	5771MHz	5752MHz	5733MHz
Code position (on/off)								



**Attention:**

- (1) Only 2, 4, 6, 8 channels are available for the TX5821(FCC) emitter.
- (2) Emitter transmitting channel and remote controller image receiving channel must be correspondent with each other.

## 10.4 Introduction for power board

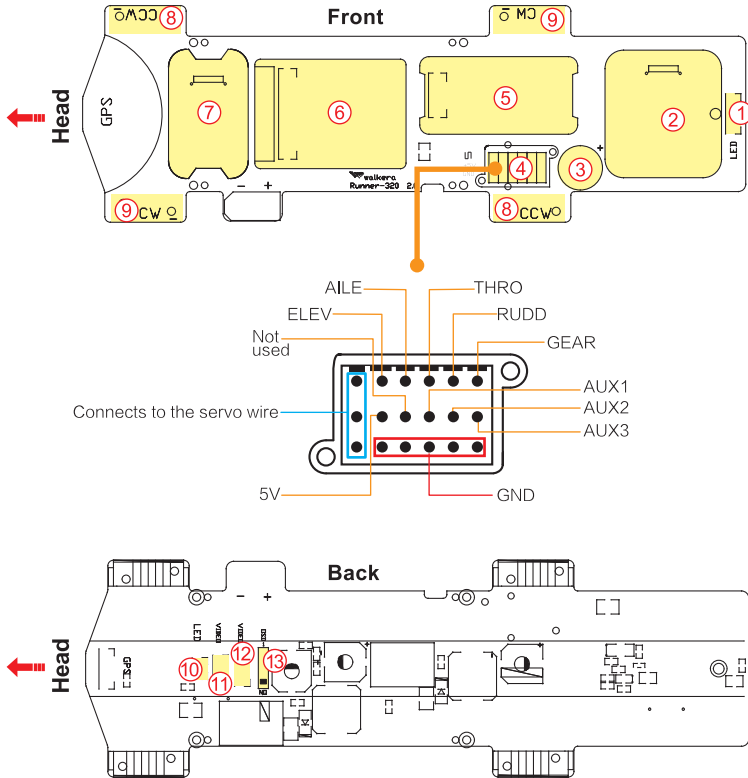

- |  |   |
|--|---|
| 1. Rear LED connection port  | 7. OSD(C) module install position   |
| 2. TX5821(FCC) or TX5820(CE) emitter install position  | 8. Brushless ESC(CCW) connect position  |
| 3. Buzzer: a kind of alarm device which will alarm automatically when the signal between the aircraft and remote controller lost suddenly or battery voltage lower than 14.2V. | 9. Brushless ESC(CW) connect position   |
| 4. Receiver input/output channel   | 10. Front LED connect port  |
| 5. DEVO-RX712 Receiver install position  | 11. 800TVL camera connect Port: (3 pins/11.1V)  |
| 6. FCS-FURIOUS 320(C) Main Controller install position   | 12. 1920x1080P camera connect Port: (5 pins/5V)   |
|  | 13. Video Switch: <input type="checkbox"/> ON Slide the switch to "ON" to start the video |



## 10.5 Introduction for FURIOUS 320 OSD(C)

### Upgrade

Please go to Walkera official website for online upgrade, cable connection as follows:

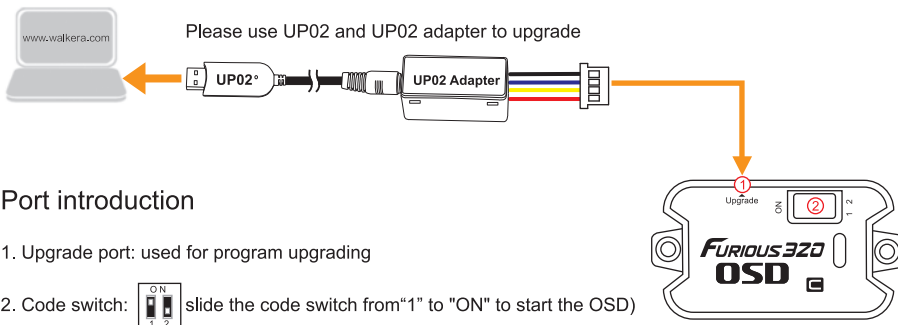

### Port introduction

## 10.6 Introduction for DEVO-RX712 receiver

### Flexible flat cable connection

The metal surface of flexible flat cable plug should be inserted upward to receiver port properly.



The metal surface of flexible flat cable plug should be inserted downward to power board port properly.

### Port introduction

1. Clean button: Fixed ID clear button
2. Idle port: Not used
3. Connection port: used to connect flexible flat cable

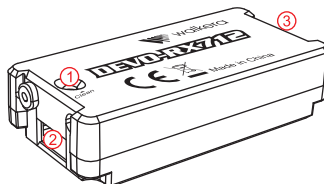

### Fixed ID code cleaning up method

If you want to clear the fixed ID after setting by Remote Controller (Fixed ID setting, details please refer the Remote Controller manual), please press the clean button and power on the aircraft. The receiver fixed ID memory is cleared if the receiver RED LED will flash slowly. Remote Controller fixed ID settings status should be OFF.

## 10.7 Introduction for FCS-FURIOUS 320(C) Main Controller

FCS-FURIOUS 320(C) main controller adopts CC3D system, with OSD module(C) can display OSD information.

### Flexible flat cable connection

The metal surface of flexible flat cable plug should be inserted upward to main controller port properly.



The metal surface of flexible flat cable plug should be inserted downward to power board port properly.

### Port introduction

1. 4 pins port: Not used
2. 6 pins port: Not used
3. USB port: used for upgrading and setting parameter
4. Connection port: used to connect flexible flat cable

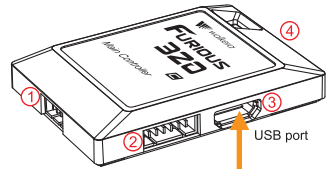

### Upgrading and parameter adjustment(OpenPilot GCS)

- (1) Upgrade: please upgrade online via Walkera official website
- (2) Parameter adjustment: please make appropriate parameter adjustment according to your own technical level. Factory files exported before the adjustment is highly recommended.

#### Connect the main board controller to the computer and run OpenPilot GCS:

**Export factory original file:** click the window file ➔ select export UAV Settings ➔ name the file and save it

**Import factory original file:** click the window file ➔ select import UAV Settings ➔ open the saved file

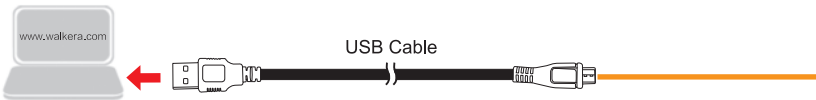

## 10.8 Brushless ESC and Brushless Motor connection diagram

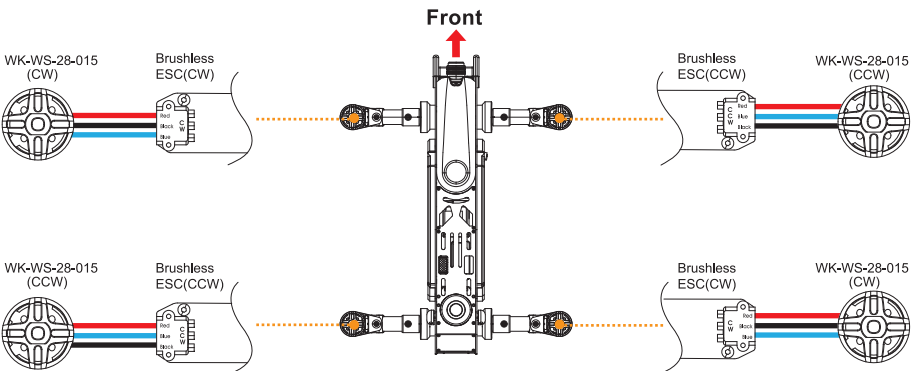

## 11.0 Camera(1920x1080P) Instructions

### 11.1 Pictures illustration

1. Shutter Button
2. Red Indicator
3. Power port(DC 5V)
4. Video/Photo Switch
5. Micro SD card slot

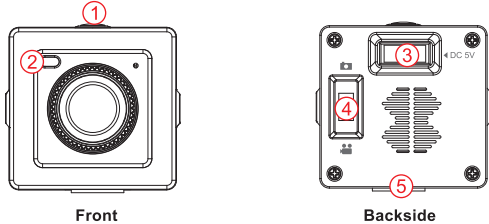

### Warm tips:

- (1) A Micro SD card must be inserted into the camera before power on and removed after power off. (A high speed SD card is recommended.)
- (2) Insert the Micro SD card, after the camera power on, the red indicator will keeps solid.

### 11.2 Video instruction

#### Manual Operation

Turn the Video/Photo Switch to , press the shutter button once to start recording (the Red indicator flashes for 0.5sec interval); Press the shutter button again to stop recording (The Red indicator keeps solid).

#### Remote Controller Operation

Switch	Remote Controller setting	Instructions
GEAR	Model Menu	① Please turn the video/photo switch to “  ” position.
	↓	
	Device Output	② <b>Start video:</b> turn the <b>GEAR switch</b> from “0” position to “1” position, wait for 1-2 seconds, then return to the “0” position, the camera will start recording ( <b>the red indicator keeps flashing with an interval of 0.5 second</b> ).
	↓	
	AUX2	<b>Stop recording:</b> turn the <b>GEAR switch</b> from “0” position to “1” position, wait for 1-2 seconds, then return to the “0” position, the camera will stop recording ( <b>the red indicator keeps solid red</b> ).
	↓	
	GEAR SW	
	↓	
	Active	<b>Note:</b> You must stop recording to store the video on the SD card. The video will not be stored if you turn off the power before stopping the recording.

### 11.3 Photo instruction

#### Manual Operation

Turn the video/photo switch to , press the shutter button once, camera will take a photo (the red indicator light out once then keeps solid red), press the shutter button again, it will take another photo.

#### Remote Controller Operation

Switch	Remote Controller setting	Instructions
<b>GEAR</b>	Model Menu ↓ Device Output ↓ AUX2 ↓ GEAR SW ↓ Active	① Please turn the video/photo switch to "  " position.  ② Turn the <b>GEAR switch</b> from "0" position to "1" position, wait for 1-2 seconds, then return to the "0" position, the camera will start to take a photo (the red indicator light out once then keeps solid red), operate again to take another photo, and so on.

## 12.0 Instructions for GA009 balance charger

### Parameters of GA009 balance charger

Input voltage	Output current	Output Power	Dimension
100-240V 50/60HZ	3.3A	60W	137 x 57 x 32mm

### Instruction of GA009 balance charger

- GA009 adopts microcomputer chips to monitor and control over the whole charging process in a balanced way with LED indicator to display the charging status at real time.
- GA009 is suitable for 11.1V/ 14.8V Li-ion or Li-polymer battery pack.

### The diagram of GA009 charger connecting to 11.1V li-po battery

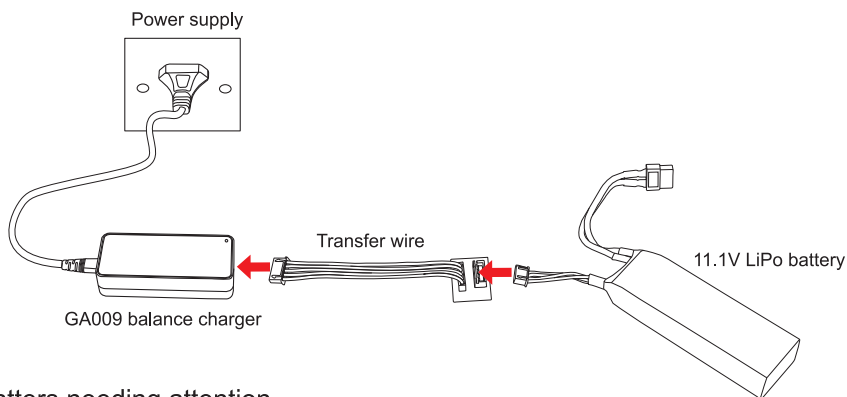

### Matters needing attention

- GA009 is only used to charging a 3S or 4S Li-ion or Li-polymer battery. It is forbidden to simultaneously charge two or more sets of batteries. Either the charger or battery may be damaged.
- During charging, GA009 should be put in dry and ventilated place and be far away from heat sources and inflammable and explosive substances.
- When charging, the battery should be removed from your aircraft. Never leave the charger unsupervised during the process of charging in order to avoid risk of accidents.
- Never immediately charge your battery as soon as the flight is finished, or when its temperature doesn't cool down. Otherwise the battery will take a risk in swelling, even a fire.
- Ensure the correctness of polarity before connecting the battery to charger.
- Avoid drop and violence during the process of charging. Drop and violence will result in internal short circuit of the battery.
- To make sure the safe use, please ensure you use the factory's charger and battery. If the battery is aging and swelling owing to long time using, please replace it in time.



 Tel: 400-9318-878

User manual is subject to change without prior notice.

Please go to Walkera official website to get the latest version.

